

External Sorting

Chapter 13

Why Sort?

- ❖ A classic problem in computer science!
- ❖ Data requested in sorted order.
 - e.g., find students in increasing *gpa* order
- ❖ Sorting is first step in *bulk loading* B+ tree index.
- ❖ Sorting useful for eliminating *duplicate copies* in a collection of records. (Why?)
- ❖ *Sort-merge* join algorithm involves sorting.
- ❖ Problem: sort 1Gb of data with 1Mb of RAM.
 - why not virtual memory?

2-Way Sort: Requires 3 Buffers

- ❖ Pass 1: Read a page, sort it, write it.
 - only one buffer page is used
- ❖ Pass 2, 3, ..., etc.:
 - three buffer pages used.

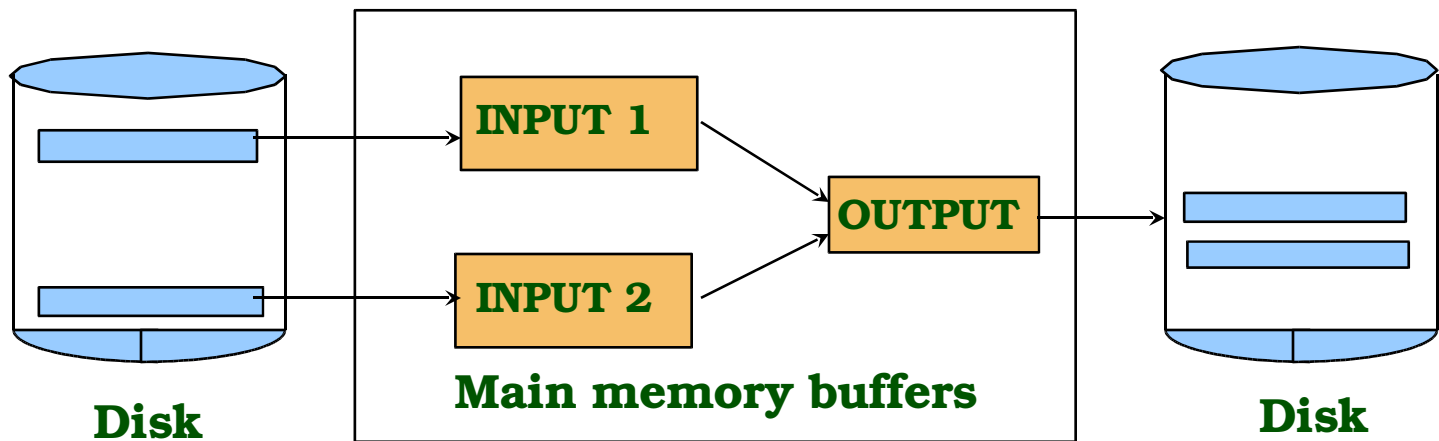

Two-Way External Merge Sort

- ❖ Each pass we read + write each page in file.
- ❖ N pages in the file => the number of passes
 $= \lceil \log_2 N \rceil + 1$
- ❖ So total cost is:
 $2N \left(\lceil \log_2 N \rceil + 1 \right)$
- ❖ Idea: Divide and conquer:
 sort subfiles and merge

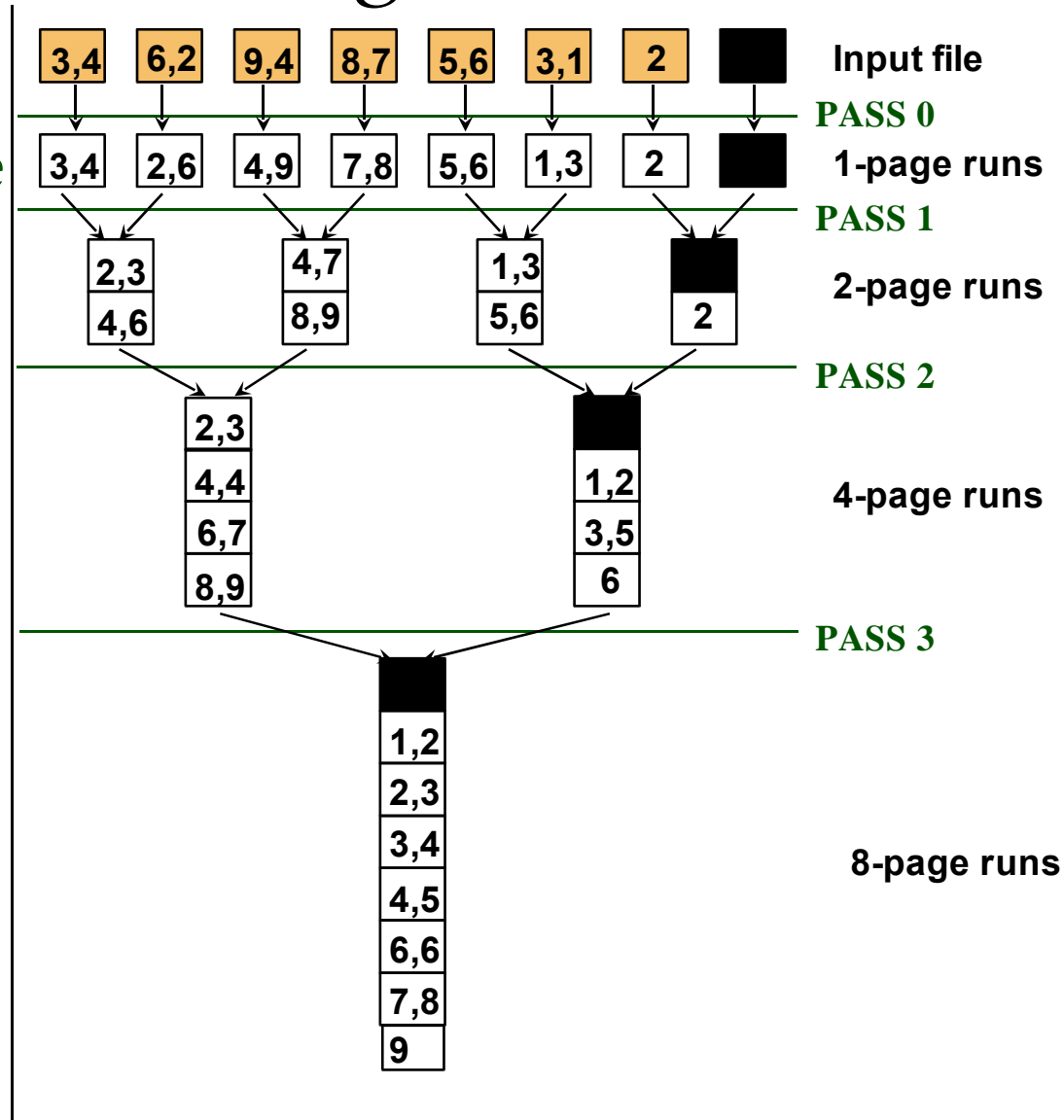

General External Merge Sort

More than 3 buffer pages. How can we utilize them?

❖ To sort a file with N pages using B buffer pages:

- **Pass 0: use B buffer pages.** Produce $\lceil N/B \rceil$ sorted runs of B pages each.
- **Pass 2, ..., etc.: merge $B-1$ runs.**

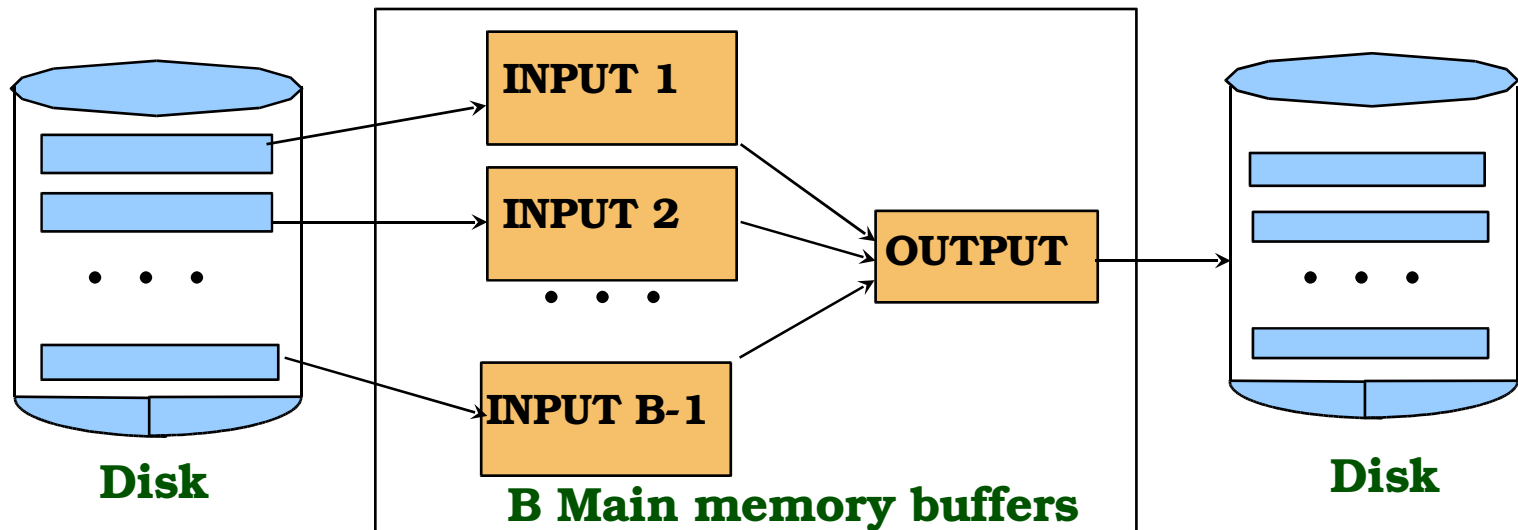

Cost of External Merge Sort

- ❖ Number of passes: $1 + \lceil \log_{B-1} \lceil N / B \rceil \rceil$
- ❖ Cost = $2N * (\# \text{ of passes})$
- ❖ E.g., with 5 buffer pages, to sort 108 page file:
 - Pass 0: $\lceil 108 / 5 \rceil = 22$ sorted runs of 5 pages each (last run is only 3 pages)
 - Pass 1: $\lceil 22 / 4 \rceil = 6$ sorted runs of 20 pages each (last run is only 8 pages)
 - Pass 2: 2 sorted runs, 80 pages and 28 pages
 - Pass 3: Sorted file of 108 pages

Number of Passes of External Sort

N	B=3	B=5	B=9	B=17	B=129	B=257
100	7	4	3	2	1	1
1,000	10	5	4	3	2	2
10,000	13	7	5	4	2	2
100,000	17	9	6	5	3	3
1,000,000	20	10	7	5	3	3
10,000,000	23	12	8	6	4	3
100,000,000	26	14	9	7	4	4
1,000,000,000	30	15	10	8	5	4

Internal Sort Algorithm

- ❖ Quicksort is a fast way to sort in memory.
- ❖ An alternative is "tournament sort" (a.k.a. "heapsort")
 - **Top:** read in B blocks
 - **Output:** move smallest record to output buffer
 - read in a new record r
 - insert r into in-memory "heap"
 - if r not smallest, then **GOTO Output**
 - else remove r from "heap"
 - output "heap" in order; **GOTO Top**

More on Tournament Sort

❖ Fact: average length of a run in heapsort is $2B$

- The "snowplow" analogy

❖ Worst-Case:

- What is min length of a run?
- How does this arise?

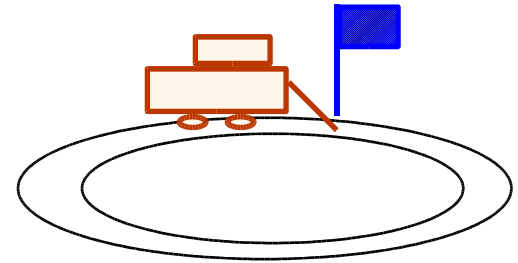

❖ Best-Case:

- What is max length of a run?
- How does this arise?

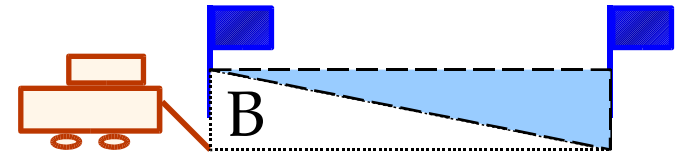

❖ Quicksort is faster, but ...

I/O for External Merge Sort

❖ For tournament sort:

- Longer runs often means fewer passes!
- However, it does I/O a page at a time.
- Slower than quicksort in number of steps.

❖ Back to quicksort:

- We can read a *block* of pages sequentially!
- So maybe we should make each buffer (input/output) be a *block* of pages.
 - On the bad side, this will reduce fan-out during merge passes!
 - However, in practice, most files still sorted in *2-3 passes*.

Number of Passes of Optimized Sort

N	B=1,000	B=5,000	B=10,000
100	1	1	1
1,000	1	1	1
10,000	2	2	1
100,000	3	2	2
1,000,000	3	2	2
10,000,000	4	3	3
100,000,000	5	3	3
1,000,000,000	5	4	3

Block size = 32, initial pass produces runs of size 2B.

Double Buffering

- ❖ To reduce wait time for I/O request to complete, can *prefetch* into 'shadow block'.
- Potentially, more passes; in practice, most files still sorted in *2-3 passes*.

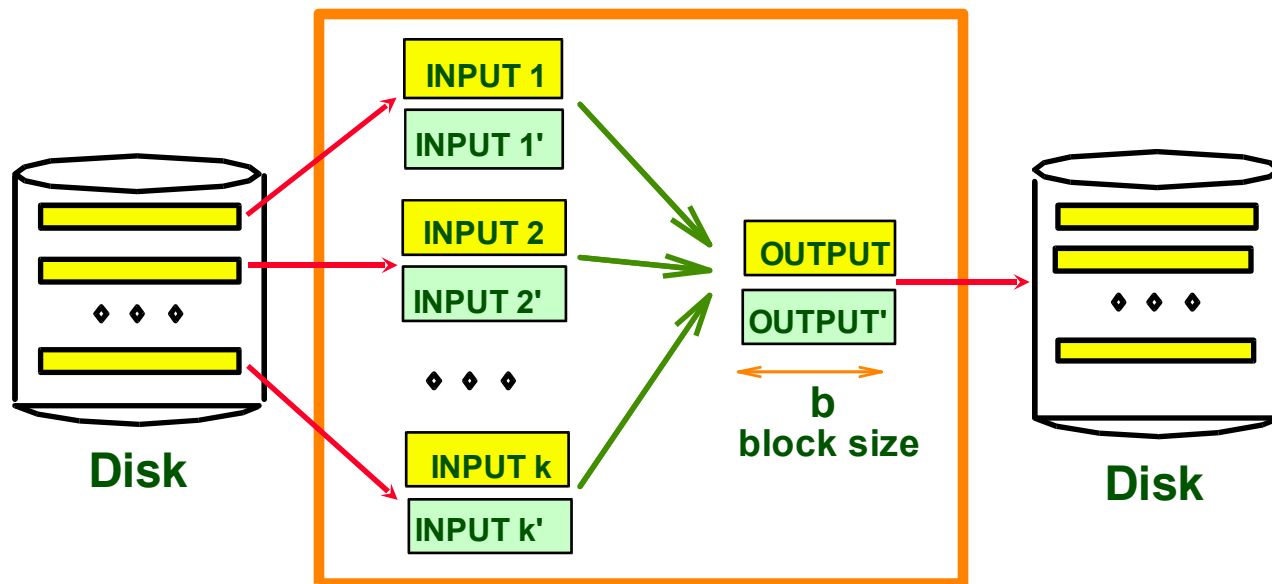

B main memory buffers, **k**-way merge

Sorting Records!

- ❖ Sorting has become highly competitive!
 - Parallel sorting is the name of the game ...
- ❖ Benchmark: Sort 1TB (10G recs, 100 bytes)
 - 2005: 7.25 minutes, SCS (IBM Almaden Research)
 - Linux 80, Itanium2, 2,520 SAS disks
- ❖ New benchmarks proposed:
 - Minute Sort: How many can you sort in 1 minute?
 - 2004: 32 GB (340M records), Nsort (Ordinal Technology)
Windows, 32 Itanium2, 2,350 SAN disks
 - Penny Sort: How many can you sort for \$0.01?
 - 2005: 15 GB (163M records), PostManSort
979 on a \$951 WinTel 2 SATA

Using B+ Trees for Sorting

- ❖ Scenario: Table to be sorted has B+ tree index on sorting column(s).
- ❖ **Idea:** Can retrieve records in order by traversing leaf pages.
- ❖ *Is this a good idea?*
- ❖ Cases to consider:
 - B+ tree is **clustered** *Good idea.*
 - B+ tree is **not clustered** *Could be a very bad idea.*

Clustered B+ Tree Used for Sorting

- ❖ Cost: root to the left-most leaf, then retrieve all leaf pages (Alternative 1)
- ❖ If Alternative 2 is used? Additional cost of retrieving data records: each page fetched just once.

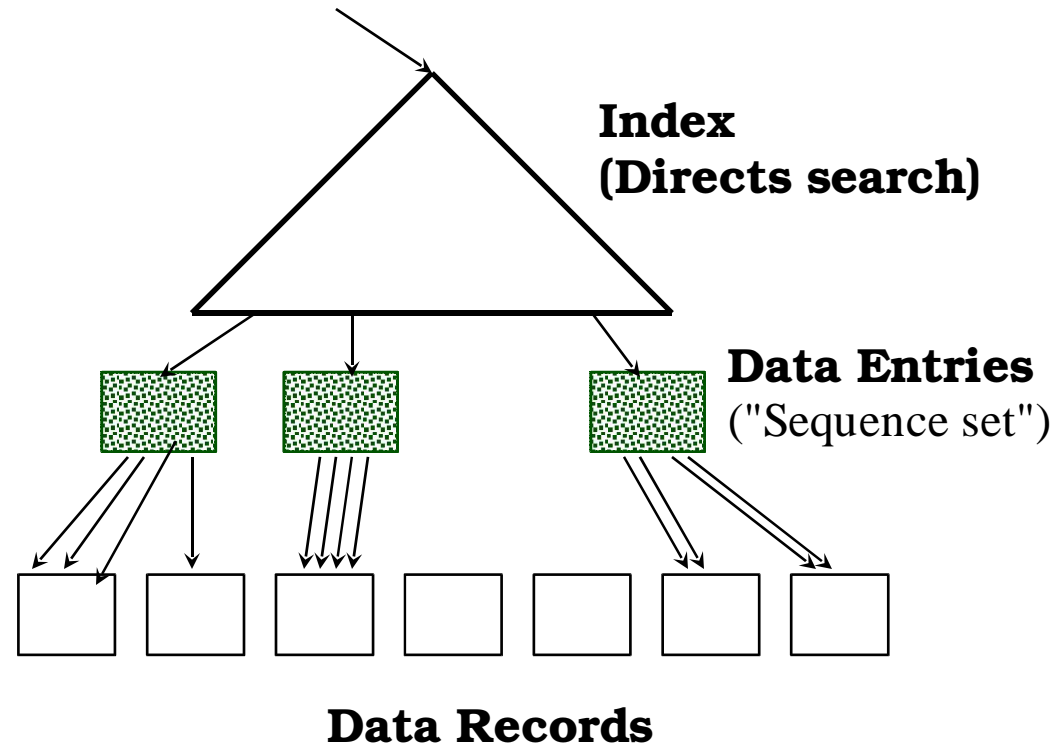

Always better than external sorting!

Unclustered B+ Tree Used for Sorting

- ❖ Alternative (2) for data entries; each data entry contains *rid* of a data record. In general, **one I/O per data record!**

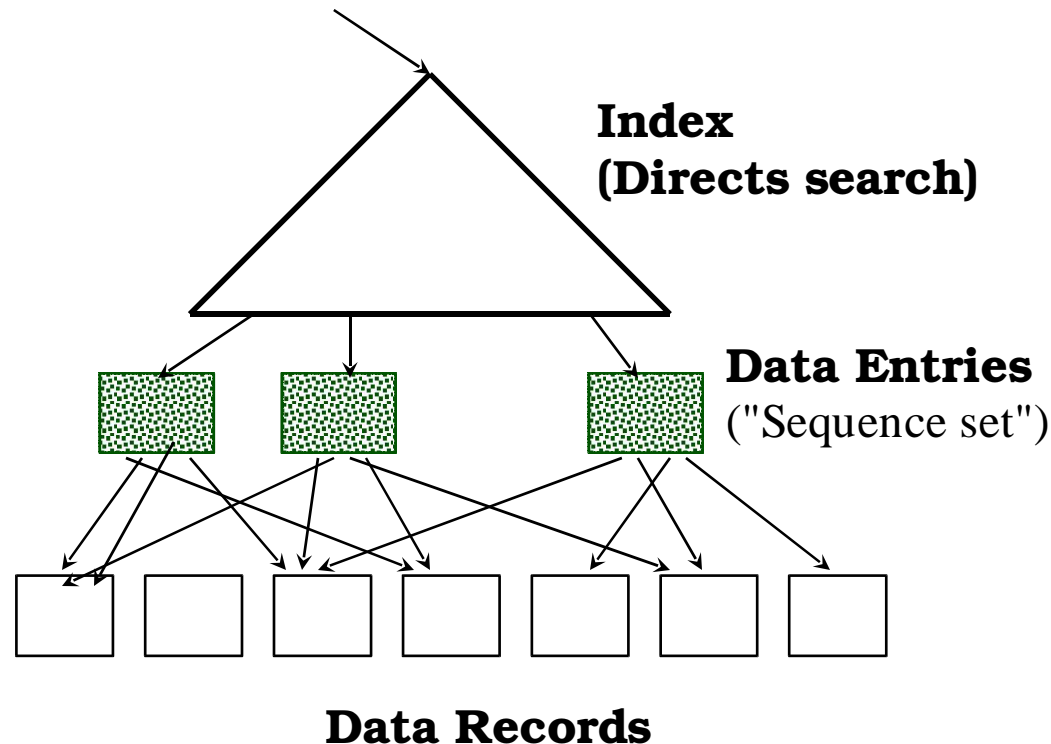

External Sorting vs. Unclustered Index

N	Sorting	p=1	p=10	p=100
100	200	100	1,000	10,000
1,000	2,000	1,000	10,000	100,000
10,000	40,000	10,000	100,000	1,000,000
100,000	600,000	100,000	1,000,000	10,000,000
1,000,000	8,000,000	1,000,000	10,000,000	100,000,000
10,000,000	80,000,000	10,000,000	100,000,000	1,000,000,000

☞ p : # of records per page

☞ $B=1,000$ and block size=32 for sorting

☞ $p=100$ is the more realistic value.

Summary

- ❖ External sorting is important; DBMS may dedicate part of buffer pool for sorting!
- ❖ External merge sort minimizes disk I/O cost:
 - Pass 0: Produces sorted *runs* of size B (# buffer pages).
Later passes: *merge* runs.
 - # of runs merged at a time depends on B , and *block size*.
 - Larger block size means less I/O cost per page.
 - Larger block size means smaller # runs merged.
 - In practice, # of runs rarely more than 2 or 3.

Summary (Cont.)

- ❖ Choice of internal sort algorithm may matter:
 - Quicksort: Quick!
 - Heap/tournament sort: slower (2x), longer runs
- ❖ The best sorts are wildly fast:
 - Despite 40+ years of research, it still is improving!
- ❖ Clustered B+ tree is good for sorting;
unclustered tree is usually very bad.