



# Multi-rate Transmissions

**John Stemberger**

COSC 6590A  
York University

Oct-3-2006

# Lecture Outline

- What is Multi-rate
- A brief look at ARF
- A in depth look at RBAR
- ARF vs RBAR
- Medium Time Metric (MTM)

# Multi-rate

- 1Mbps - 11Mbps
  - depends on hardware, distance, etc.
- Modulation schemes
  - encode bits into symbols.
  - data rate = bits per symbol
- SNR and BER
  - the higher the data rate the higher the bit error rate

# Faster Isn't Always Better

## Advantages of Speed:

- We all want data faster
- Bandwidth is a scarce resource for MANETS

## Disadvantages of Speed:

- SNR and BER

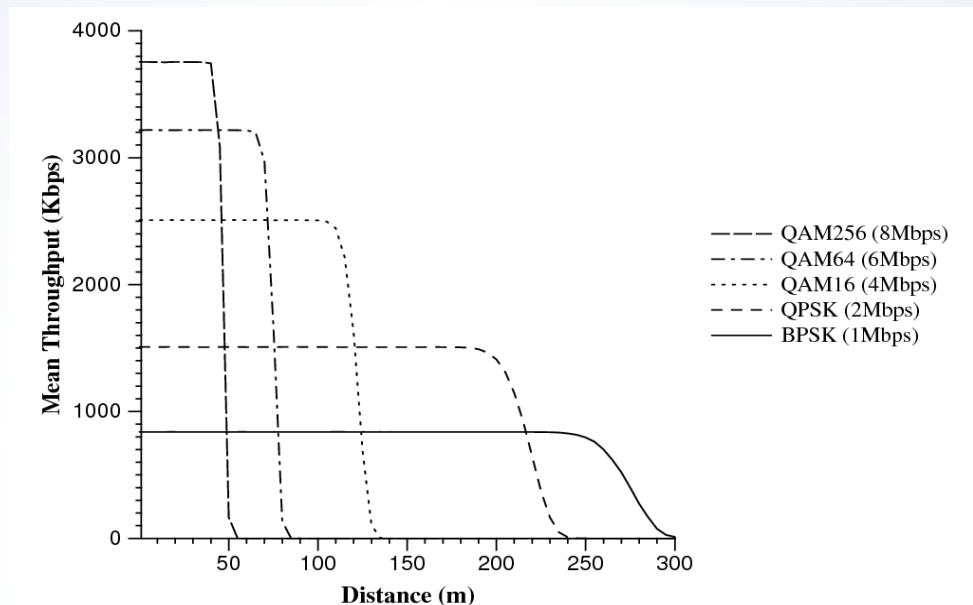

# Rate Adaption

- Channel Quality Estimations
  - Accurate
  - Up to date
  - Destination (RBAR)
  - Source (ARF)
- Rate Selection
  - predetermined thresholds for transmission rates
    - may not be known exactly so we have to estimate

# Auto Rate Fallback - ARF

- Source updates rate depending on ACKs received
- Drop transmission rate if ACKs are not received
- Increase transmission rate if timer expires of 10 consecutive ACKs are received

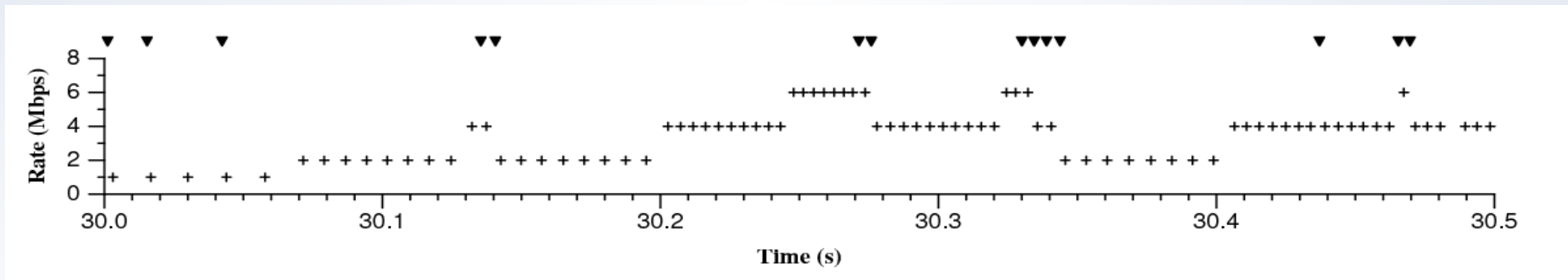

# Summary of ARF

## Advantage

- adapts to changes in the network

## Disadvantages

- Estimate calculated by the source
- Estimate based on past ACKs not on channel quality
- Takes a long time to detect changes

# Receiver Based Auto Rate (RBAR)

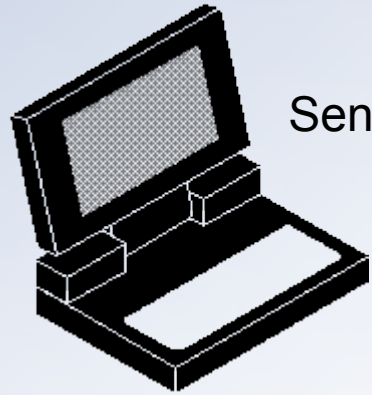

Sender



Receiver



# Receiver Based Auto Rate (RBAR)

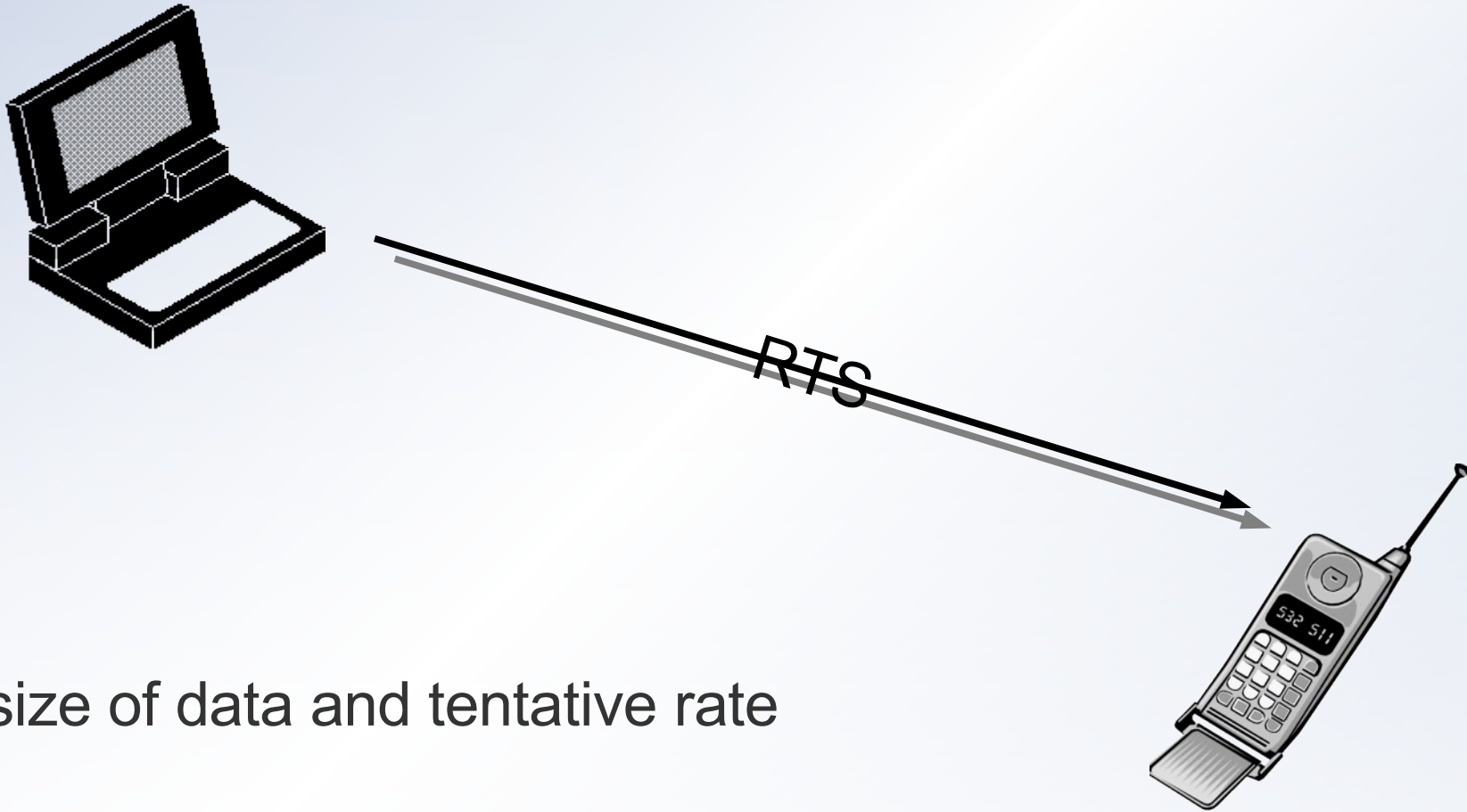

- size of data and tentative rate

# Receiver Based Auto Rate (RBAR)

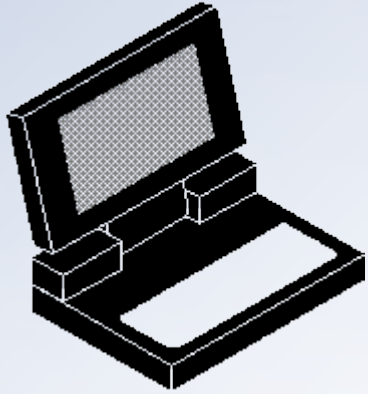

- Measure channel quality and pick a rate

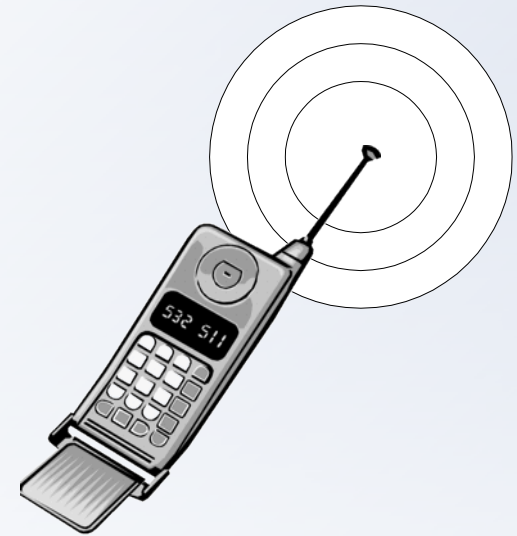

# Receiver Based Auto Rate (RBAR)

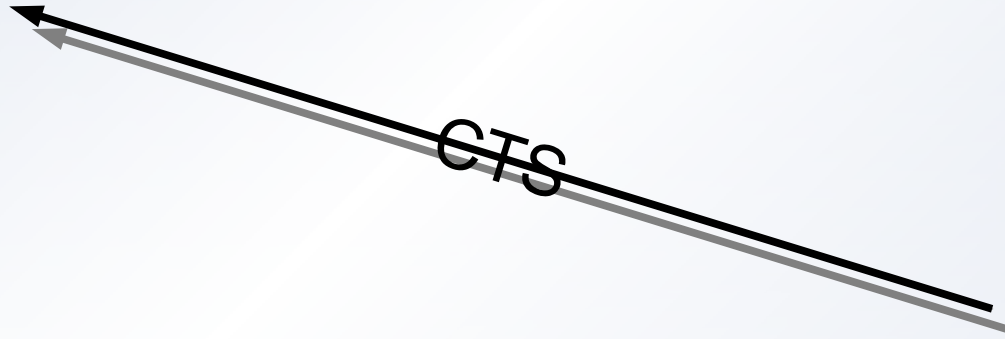
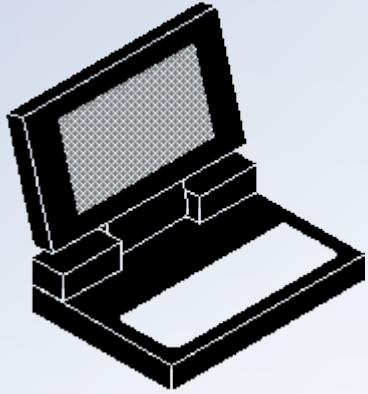

- size of data and selected rate

# Receiver Based Auto Rate (RBAR)

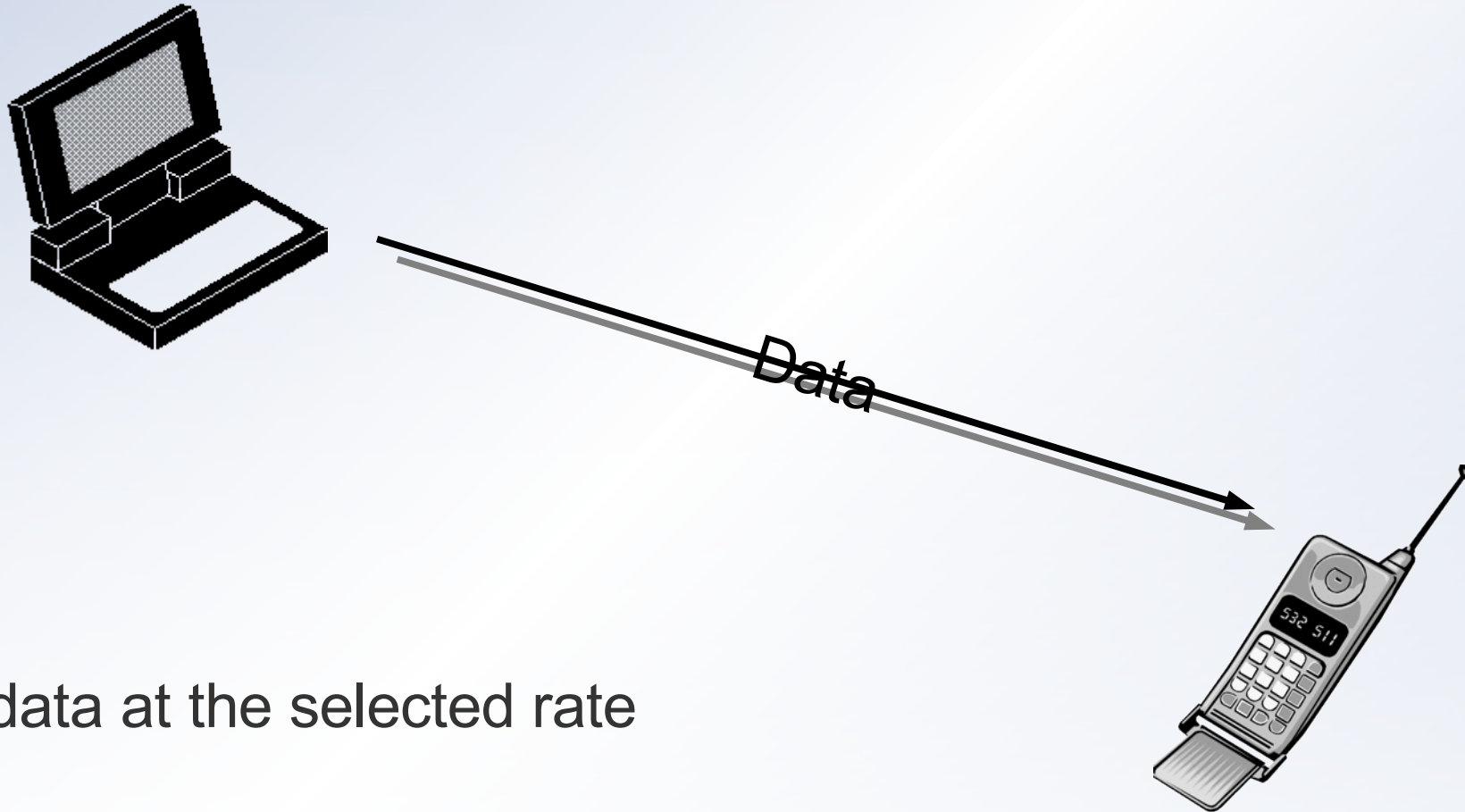

- data at the selected rate

# Receiver Based Auto Rate (RBAR)

- Select rate using the RTS/CTS
  - selected per packet
- Selection made by destination
  - Noise on receiver end determines ability to receive packet
  - receiver has more information than the sender
  - transmitting estimate data can be expensive
- Implemented in 802.11 with minor modifications
  - DCF
    - RTS/CTS
  - NAV
  - Data packet header

# Modifications to RTS/CTS

- replace duration with modulation and size of data
  - all nodes can compute the duration from this

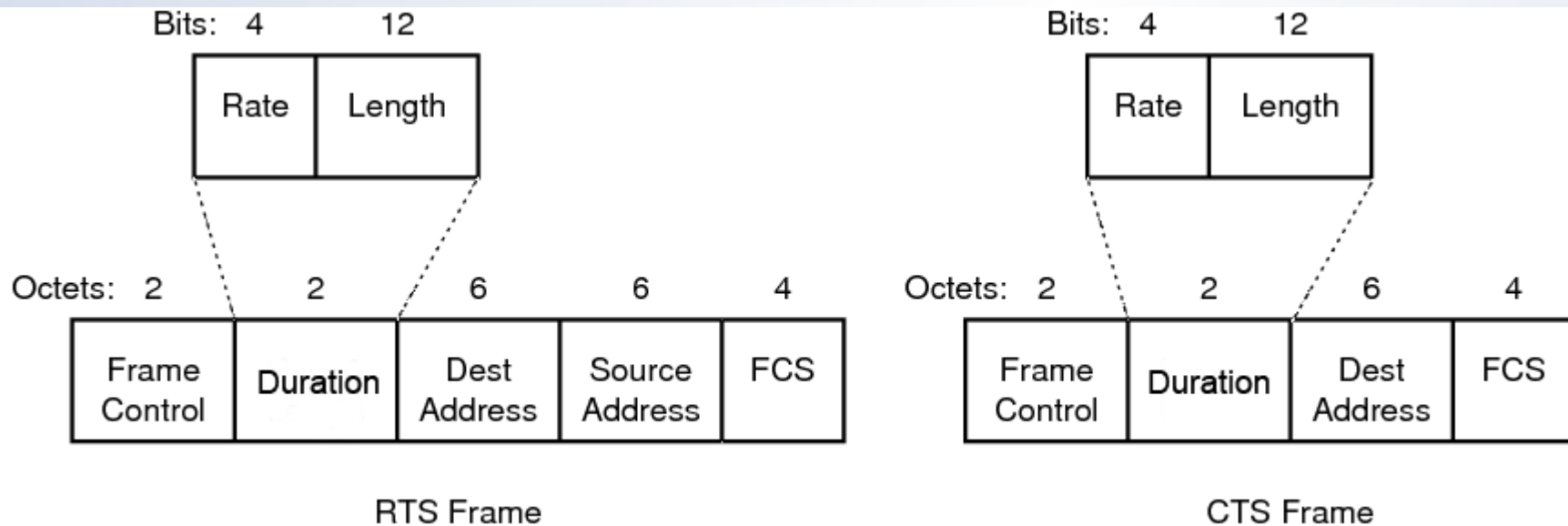

- Destination uses RTS to measure quality of channel and returns a selected rate in the CRT

# Hidden Terminals may have an outdated Reservation

- If destination selects a different speed then A will have a wrong duration

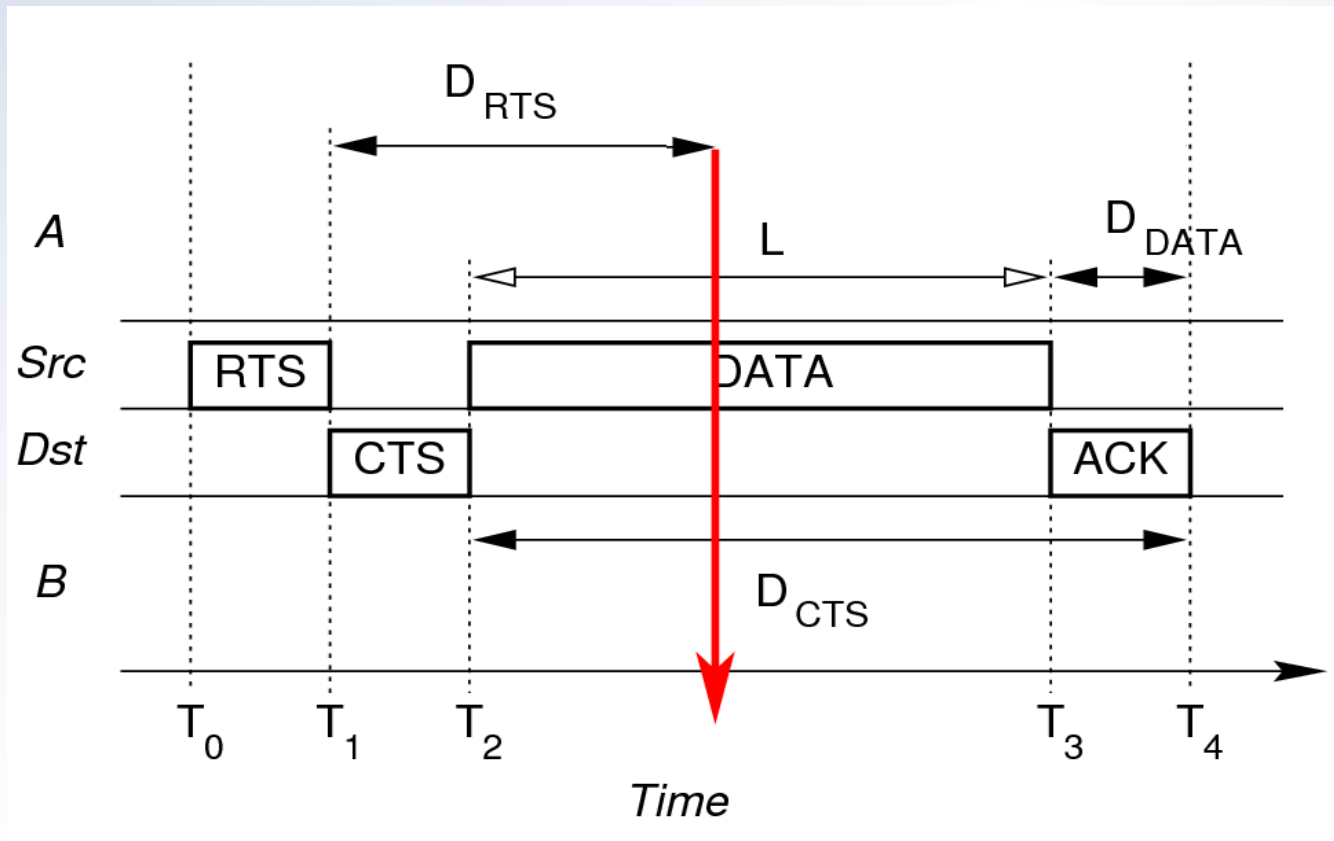

# Have to modify data header to compensate

- Add a Reservation sub header (RSH) to all data packets
  - added to the MAC header
  - all hidden terminals will have to recalculate duration based on this
    - have to modify NAV to allow updates

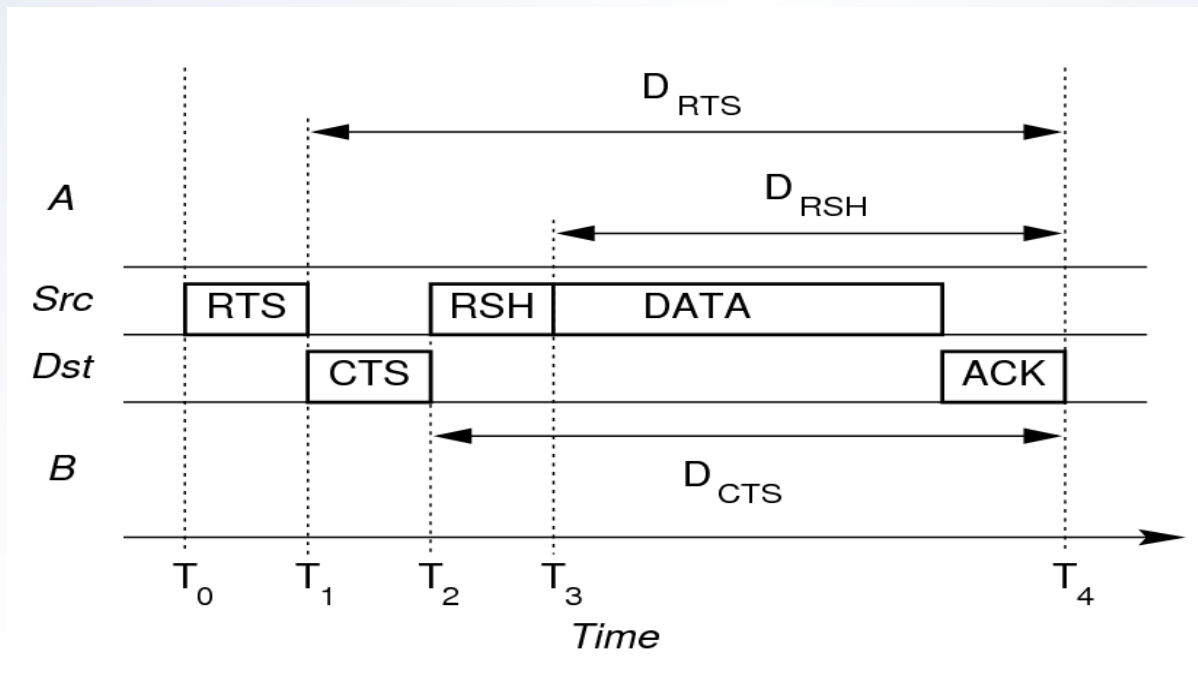



# MAC Header Modifications

- Added header check sum(HCS)
- unique frame control number to distinguish from other mac headers

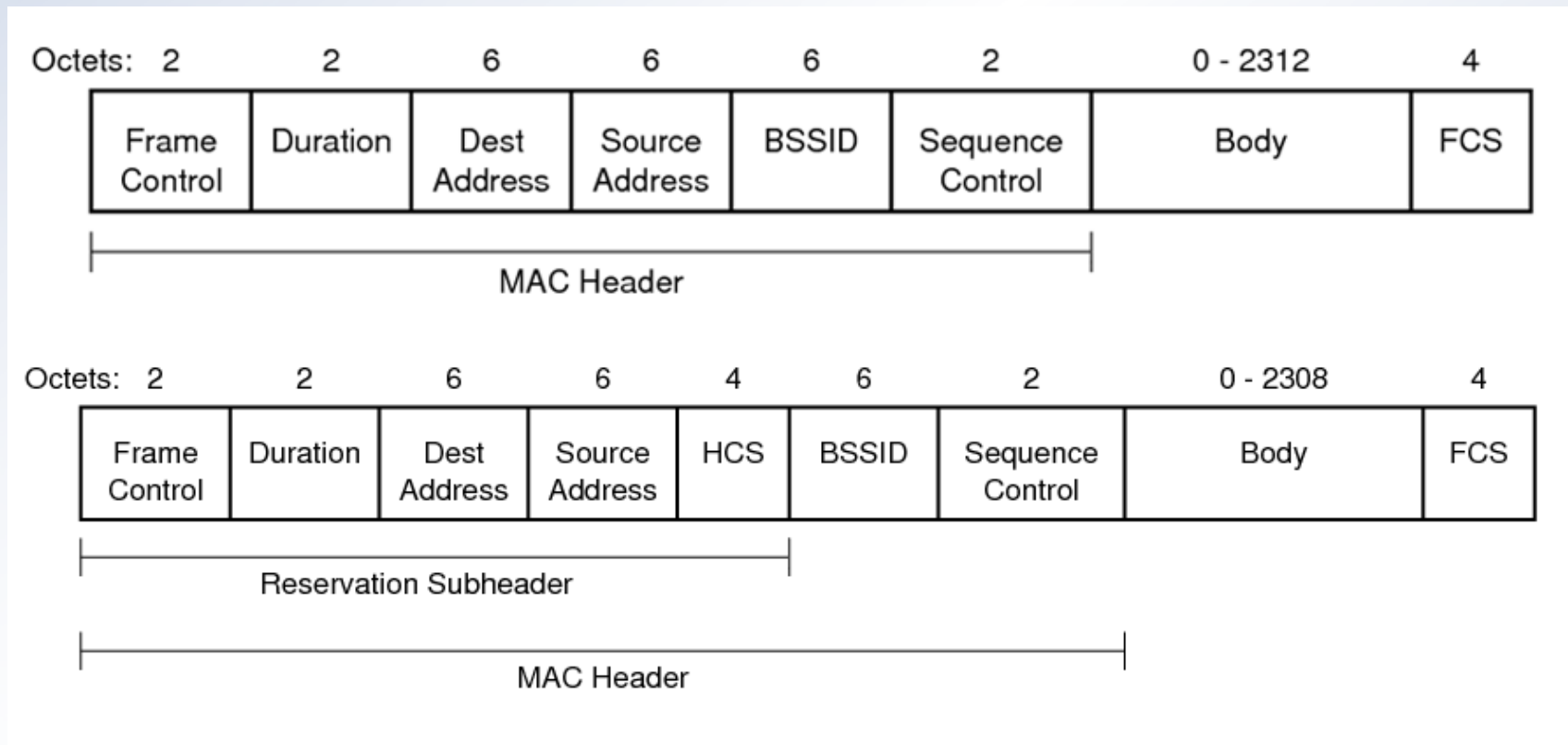

# The physical Layer also has to be modified

- So hidden terminals can understand the MAC header

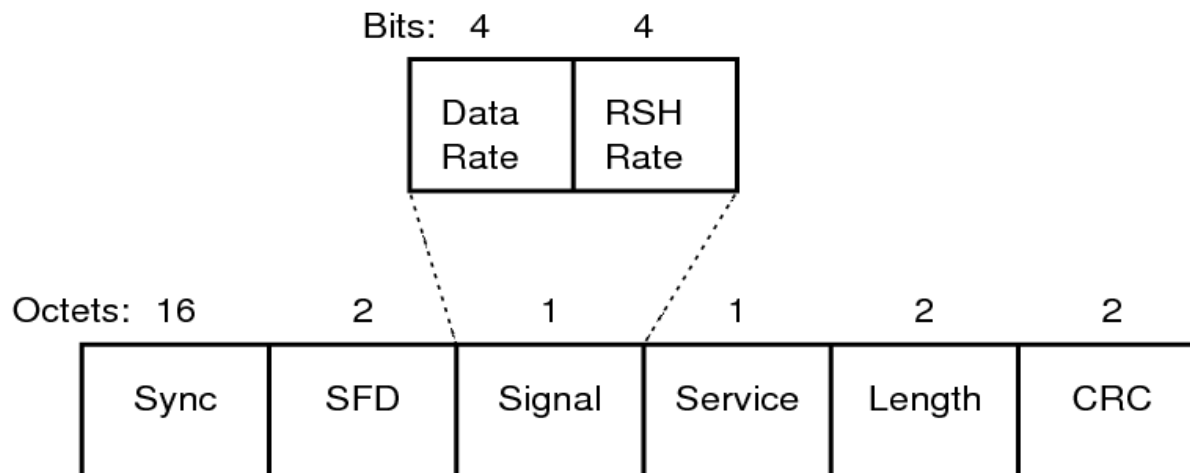

(c) Physical layer (PLCP) header.

- Signal transmission may require 2 physical transmission rate switches instead of 1
  - one switch to send the MAC header
  - one switch to send the data

# The New DCF

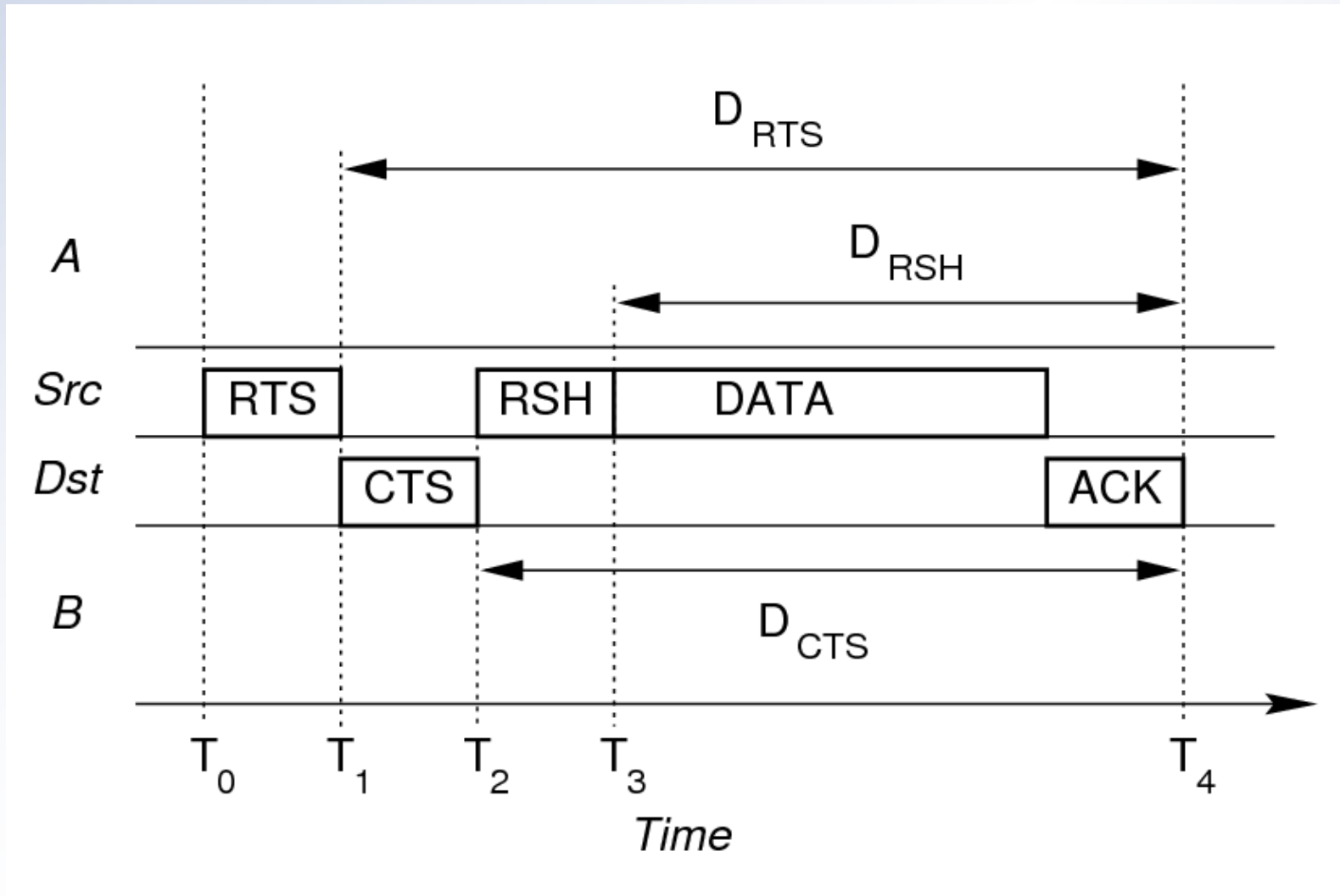

# Summary of RBAR

## Advantage

- estimate is more accurate
  - base on more complete information
  - closer to actual transmission
- can be implemented into 802.11

## Disadvantages

- More overhead for RSH
  - HCS
  - Slower MAC header
- Routing protocol prefers long unreliable links

# ARF vs RBAR - Simulation Environment

## Configuration 1:

- Single connection between two nodes
- one node fixed, the other moving in a straight line at 2 m/s
- Rayleigh fading channel

## Configuration 2:

- 20 nodes in a 1500x300 m area
- Nodes randomly places at start and followed a randomly chosen path (random waypoint mobility pattern)
- randomly chooses speed of  $\pm 10\%$  of mean speed
- Mean speed of 2, 4, 6, 8, and 10 m/s
- DSR routing

# ARF vs RBAR - C1

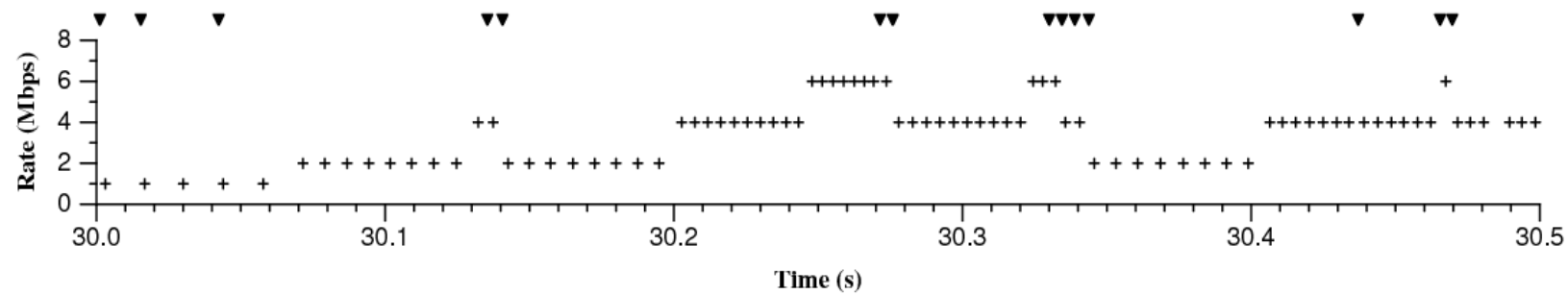
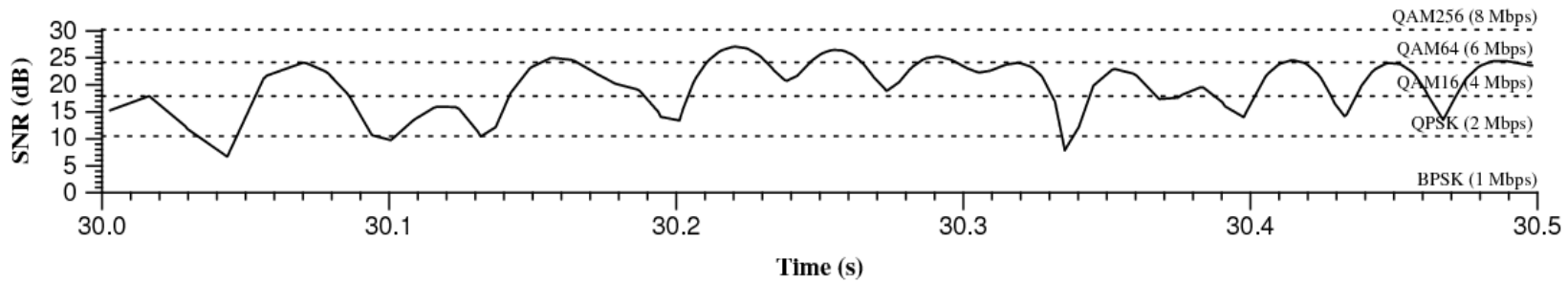

ARF

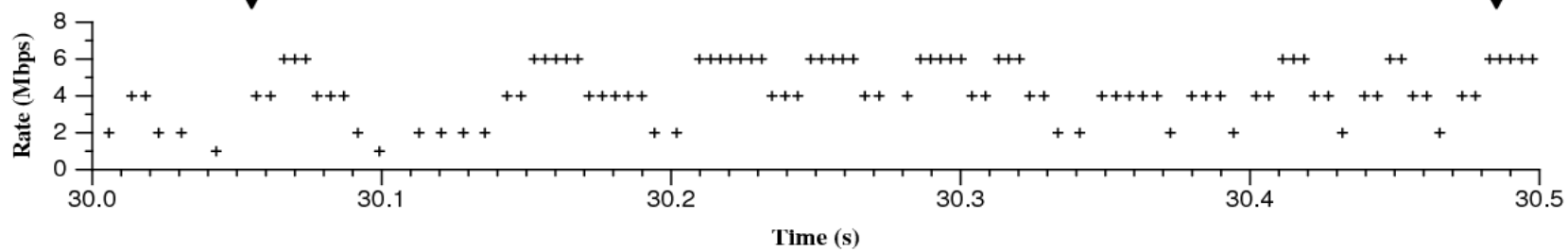

RBAR

# ARF vs RBAR - C1

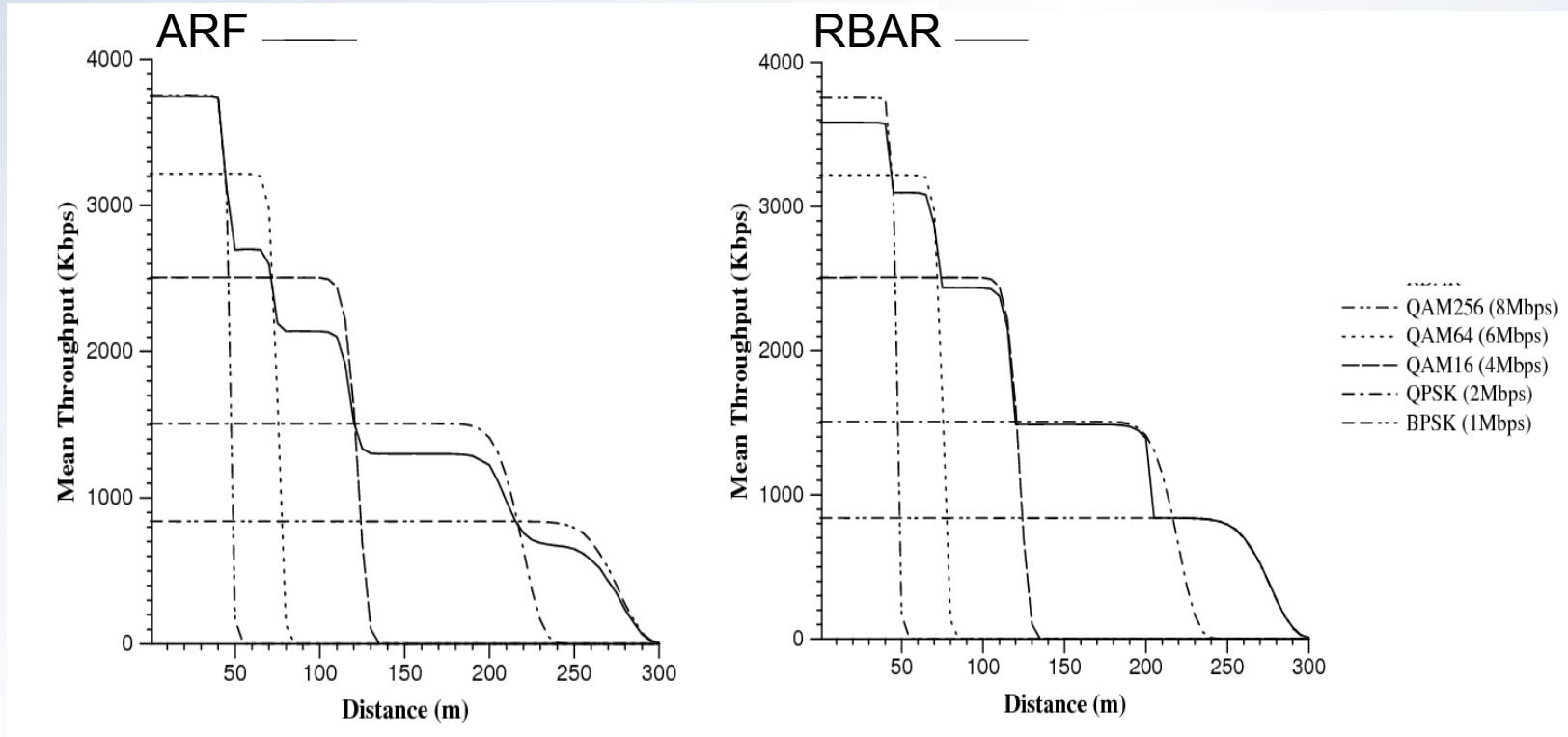

# ARF vs RBAR - C2

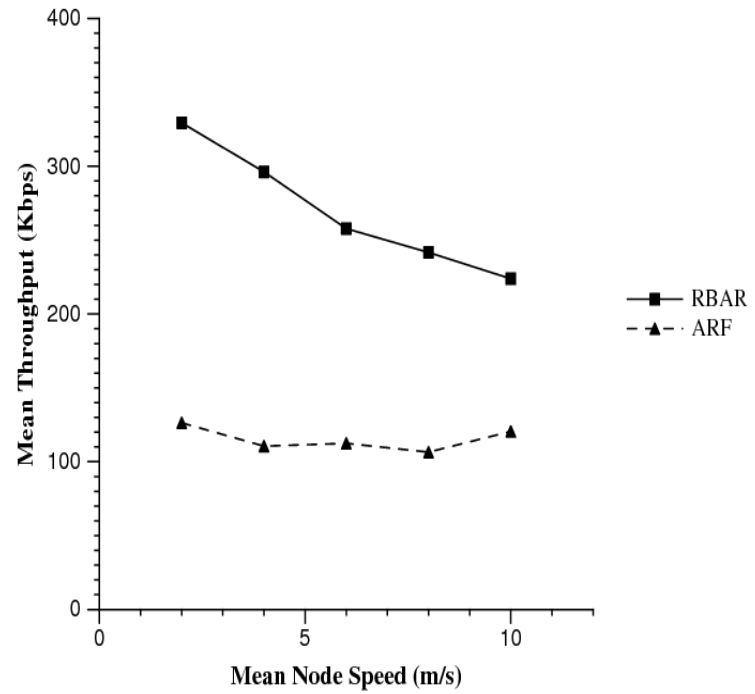
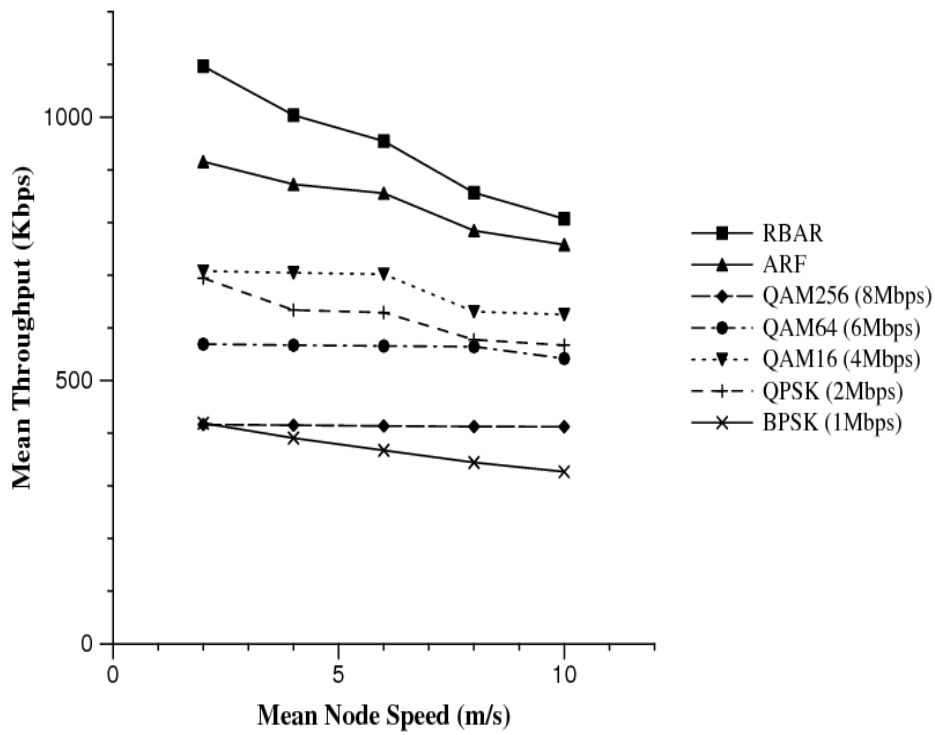



# Shortest Path leads to longer links

- Routing protocols make decisions based on a min-hop metric
- Slower transmissions go farther
  - dominate medium longer - no temporal fairness

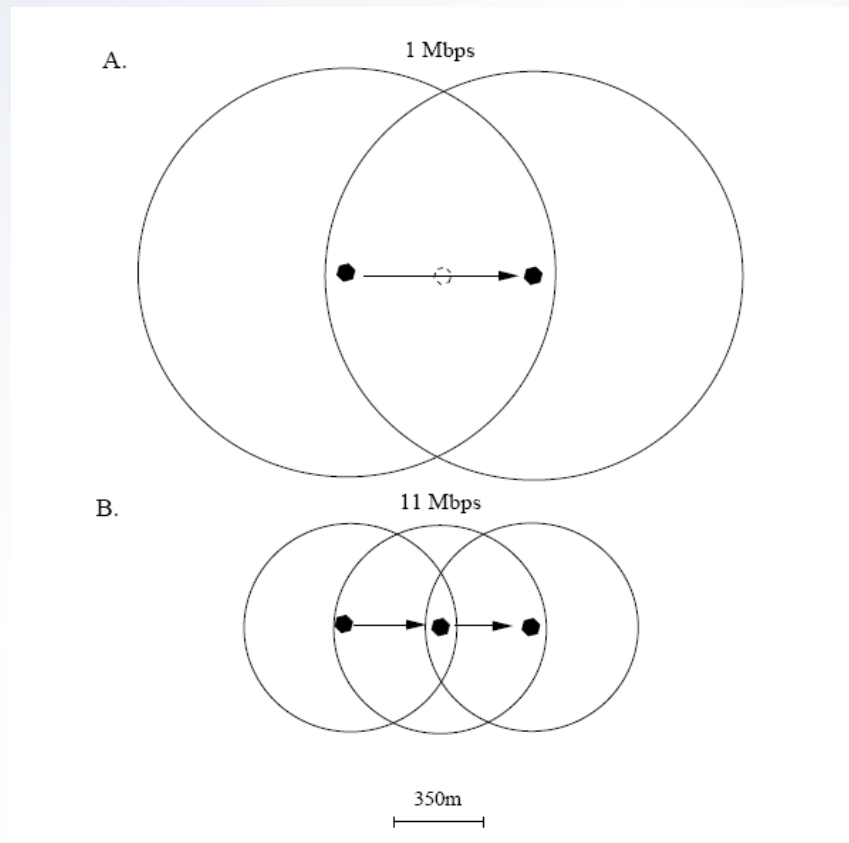

# Longer Paths with Faster Links can Lower throughput

- Neighboring nodes have to defer transmission

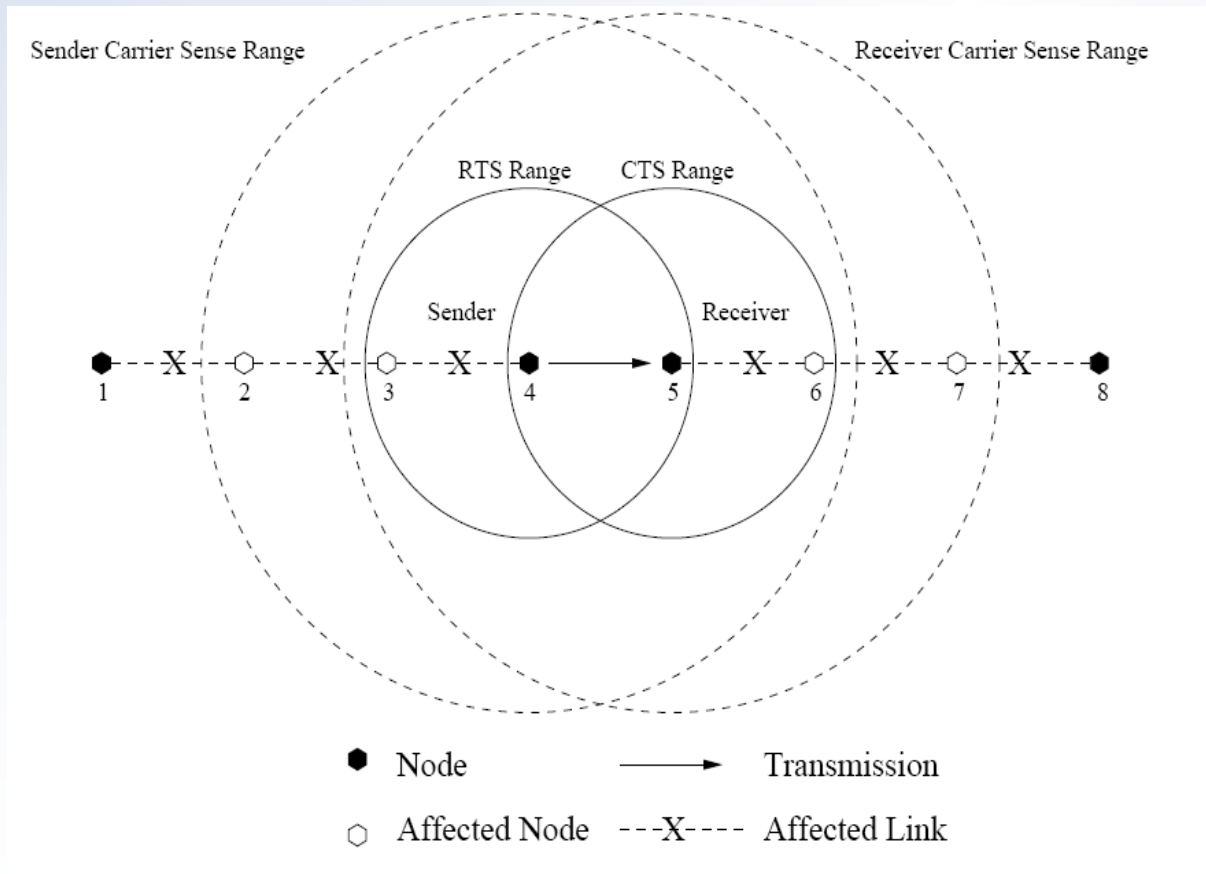

# Modify routing protocol to account for time

- Minimum Hop Path
  - fewest number of hops from source to destination
- Shortest Widest Path
  - shortest path that uses the fastest bottleneck
- Least Cost Path using a different metric

# Medium Time Metric (MTM) is better

- Minimize end to end time for the packet to be sent
  - better use of the scarce resource
  - alter weights to reflect time taken to send a packet between two nodes
    - inverse link speeds?
      - doesn't take packet overhead into account
      - small packets at slow speeds will take the same amount of time as large packets at fast rates

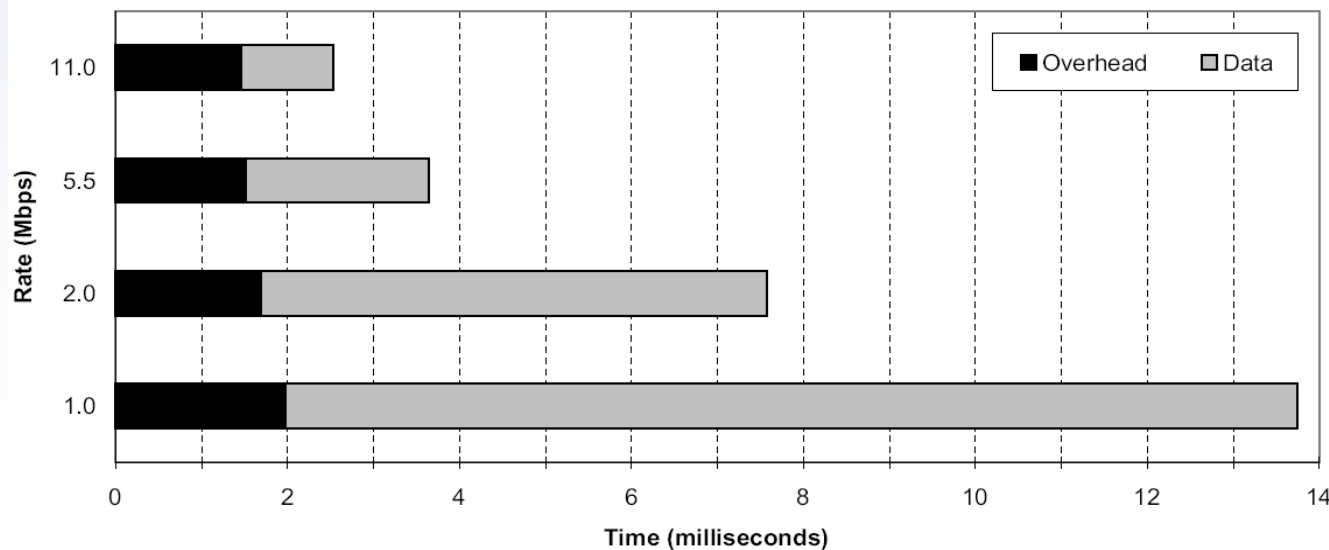

## Weights should be packet size dependant

- different set of weights for each packet size on the network

Link Rate	Inverse Weights	MTM wieghts
11	1	1
5.5	2	1.44
2	5.5	3
1	11	5.45

# Implementing in current routing protocols

- Link State Protocols

- each node computes next hop based on local connections
- topology information already present to alter paths using different weights depending on packet size

- Distance Vector Protocols

- each node has a full topology of the network by sharing their routing tables
- requires extra communication for each added weight
  - tune the weights to the standard packet size

# Quick look at OAR & Simulation Environment

- Opportunistic Auto Rate
  - receiver based
  - allows high-rate multi-pack bursts
- Simulation Environment
  - maximum speed of 20 m/s
  - pause time as low as 0 seconds
  - Min Hop was calculated by DSDV
  - MTM was tuned to TCP traffic of 1460 byte packets
  - variable number of nodes

# MTM improves throughput

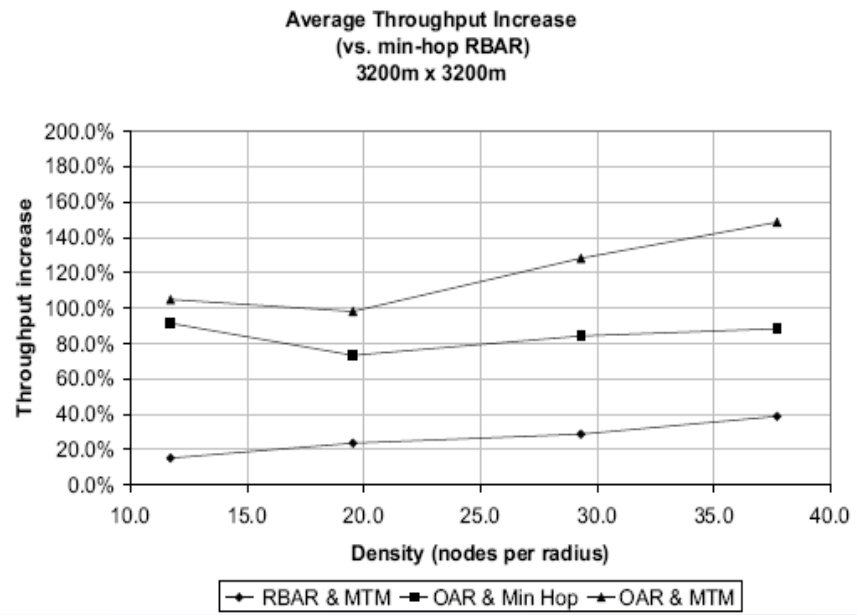
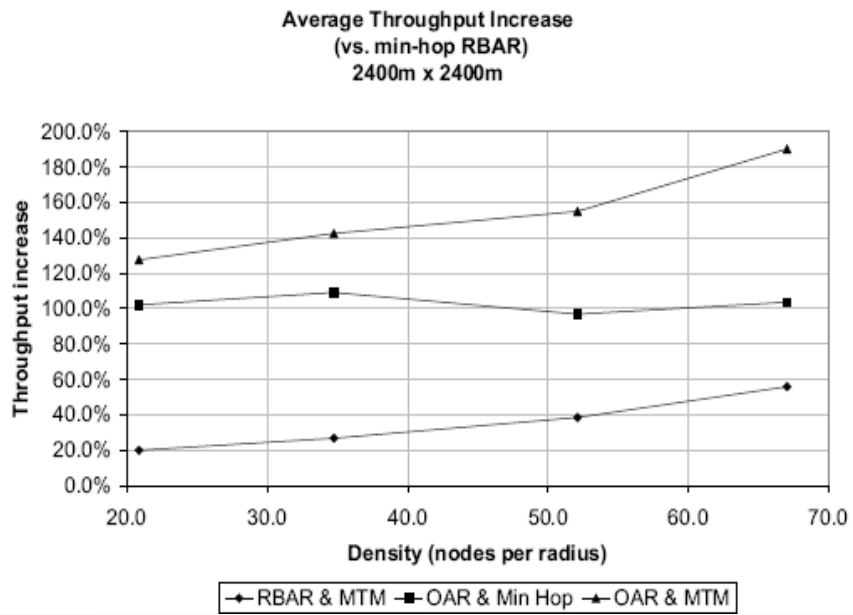



# Summary of MTM

## Advantage

- shortest path metric can be added to distance vector and link-state
- only needs to track changes in link rates
- routes do not depend on traffic patterns
- minimizes total interference

## Disadvantages

- weights of connections depend on size of packet
- doesn't deal with high mobility

# Lecture Summary

- multi rate transmissions can increase throughput
- receiver can estimate channel quality better than the sender
- the closer the estimate is to the transmission the better the estimate
- RBAR adapts to changes in signal strength quickly
- MTM will increase throughput by minimizing the use of the scarce resource of bandwidth

## Resources

- A Rate-Adaptive MAC protocol for Multi-Hop Wireless Networks, G. Holland, N. Vaidya, P. Bahl
- High Throughput Route Selection in Multi-Rate Ad-Hoc Wireless Networks, B. Awerbuch, D. Holmer, H. Rubens
- WaveLAN-II: A high Performance Wireless LAN for the Unlicensed Band, A. Kamerman, L. Monteban
- Opportunistic Media Access for Multirate Ad hoc networks, B. Sadeghi, V. Kanodia, A. Sabharwal, E. Knightly